

NEW VOLUMES™



Collection 02 — Terracotta
A warm, robust and time-honoured material, renowned for
its practical durability and impressive colouration.



Collections for the home and office by Artedomus, New Volumes™ explores and pushes the boundaries of a single natural material. For each collection, we select a distinct assembly of designers to bring the material to life.

Collection 01 explores Elba: a rich, complex stone 250 million years in the making. A material with a story, cut by machine and finished by hand into an object whose story is yet to be written. The result is collection of products that are sincere, serene and strong. Designs that will inspire and enhance the everyday.

NEW VOLUMES™
Collection 01 — Elba



Hurlysi c/o
Thomas Coward



At 720mm and 500mm in height, Hurlysi low and Hurlysi high are carved out of a single piece of Elba stone.

A solid piece of Elba is carved to create a cantilevered resting surface for objects. This is stone at its purest: simple, distinctive and statuesque. Cut to heights of 500mm or 720mm, each side table is available individually or as a complementary pair.

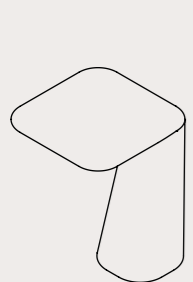

Hurlysi Low
400 x 400 x 500H

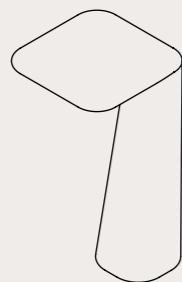

Hurlysi High
400 x 400 x 720H

Hemera c/o
Ross Gardam



Light is emitted from the column to the underside of the shade, and in turn, down onto the table surface.

Just like the brutalist architecture from 60 years ago that it references, the Hemera desk lamp is powerful in its simplicity of form. Two solid circular volumes intersect with no overtly visible light source, creating a striking desktop monolith and a lighting device of refined functionality.

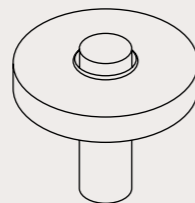

Hemera
ø 390 x 362H

Wyrie c/o
Nick Rennie



The optimal table top thickness was achieved in order to strike a balance between strength and beauty. Elba's distinct grain makes every surface unique.

The grandest statement of Collection 01. Three precise slabs of Elba unite to form a dining table without comparison. A slender rectangular table top rests upon two beautifully angular bases. Inherently durable and with a powerful presence, it seats six to eight diners. Custom sizes can be made to order.

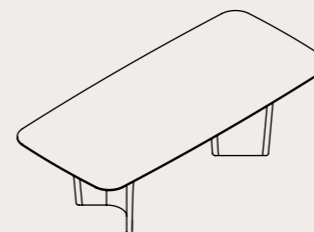

Wyrie
2400 x 1100 x 720H

Napoleon & Josephine c/o
Sarah King



Two dependent sculptural forms come together to create a pleasingly weighty mortar and pestle.

Used in kitchens for thousands of years, there remains a no more satisfyingly primal way to mix dry ingredients than a mortar and pestle. King's take on the kitchen staple is distinctly sculptural, while the natural heaviness of Elba makes for an extra solid base and pleasingly weighty pestle. Together, they make an extra-effective pairing.

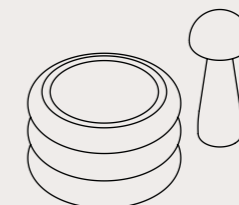

Napoleon & Josephine
Mortar ø 175 x 110H
Pestle ø 65 x 150H

Spomenik c/o
Marsha Golemac



Contrasting square and circle motifs complete a sense of quiet harmony in Spomenik I (above) and Spomenik II (right), a bowl and vase by Marsha Golemac.

A pair of complementary forms, Spomenik I and Spomenik II are characterised by their graduated volumes, realised through the careful refinement of a single slab of raw stone. Inspired by modernist monuments built in honour of the historic troubles of the Balkan Peninsula, Golemac draws on a socialist utopian ideology to marry form and function. As a bowl, vase or objet d'art, each piece references remnants of the past whilst speaking assuredly of the future.

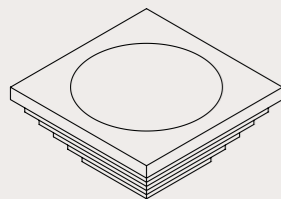

Spomenik I
380 x 380 x 180H

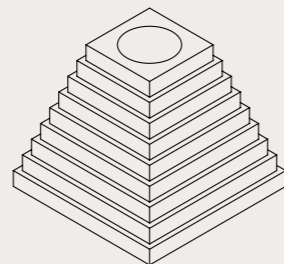

Spomenik II
300 x 300 x 270H

Semper c/o
Dale Hardiman



The Semper Planter (above) and Semper Vase (right) are designed to allow Elba's grain to be visible from all angles.

Comprised of pedestal and planter, these cylindrical forms are designed with minimal design language to allow the solid Elba stone to be the focus. The full structure of the stone's grain is visible from all angles — you can see it running an entire 360-degree revolution. Resting on top of the pedestal, the planter removes any visual impairment between the stone and its plant inhabitant.

A short statured vase made from solid stone in two parts, the Semper vase is designed to highlight fallen leaves and petals through capturing them on its platter. Doing so, it celebrates both the life and death of its inhabitants.



Semper Planter
ø 400 x 1150H

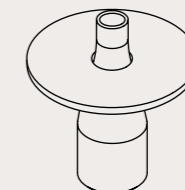

Semper Vase
ø 260 x 300H

Artemis c/o
Emma Elizabeth



Raw edges evoke a feeling as if someone has literally hacked into the natural formation of the stone and created the piece themselves.

A minimal expression referencing the traditional way in which solid stone is quarried, the Artemis series of offset candle holders cast non-regular rays of delicate light — aiding ambience at any experiential moment.

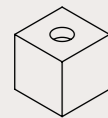

Artemis I
110 x 110 x 110H

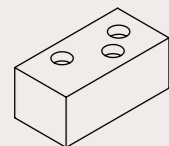

Artemis II
260 x 130 x 110H

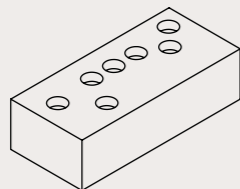

Artemis III
400 x 180 x 110H

Bacchus c/o
Tom Skeehan



A hollowed cavity functions as a bowl to be filled with fruit, flowers, ice or whatever you desire.

While built from simple forms, Bacchus is a table that's intended to spark curiosity. Comprising three legs, minimal oval top and hollowed bowl cavity, each form unites to create a centrepiece encouraging you to style it in a way that fits your function and curiosity. Exaggerated proportions and the weight of each element grounds the table, giving it a permanent place in its environment.

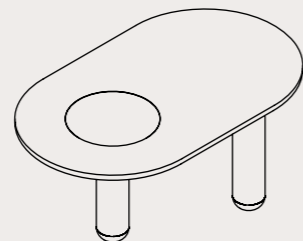

Bacchus
1000 x 600 x 425H

Lydn c/o
Thomas Coward



Representative of both water and sound, Lydn's polished surface reflects light and shows movement.

Lydn's exaggerated ripple is representative of both water and sound. Designed to capture a stylised moment in time, its form creates a sense of movement in an otherwise static material. The name comes from the Cornish word for lake, reflecting the designer's heritage.

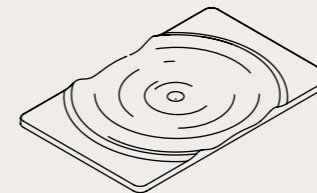

Lydn
600 x 380 x 45H

Undara c/o
Nick Rennie



Its beautiful continual curve and the natural grain of Elba give Undara a simple yet striking presence.

Evocative of a volcanic crater, Undara is a fruit bowl with a simple form yet a striking presence. At 394mm in diameter, its large surface area is distinct in every piece thanks to Elba's unique grain. Its continuous curve is accentuated with a precision sculpted rim.

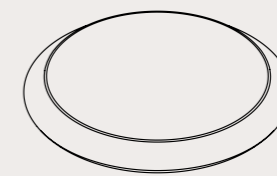

Undara
ø 395 x 82H



Collection 02 explores a fundamentally pure material, Terracotta. Terracotta is essentially fire and clay. The first manufactured material perhaps. Mud, water and heat or time. Solidifying to a robust striking colour. It is used in one way or another all over the world and much like marble, the applications cannot be restricted.

A material rich in history and culture yet still has the most contemporary properties. We can throw, cast, and extrude it to our needs and no matter what we do - we do not alter its nature.

NEW VOLUMES™
Collection 02 — Terracotta



Pitcher c/o
Adam Goodrum



The Pitcher Table (above) and Pitcher Stool (right) create sculpturally simple forms so that when they are not being used, they can sit as contemporary objects to enhance peoples' spaces.

Capturing the purity of geometry and mathematical balance, this table and stool set features an extruded square base with the top rotated 45 degrees, then married together. The pieces have been designed to be adaptable; the stool edges have a user-friendly lip making them easier to move to suit changing needs.

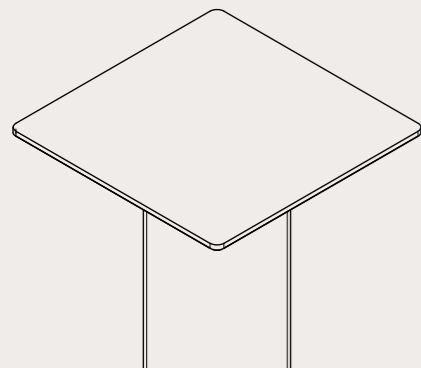

Pitcher Table
900 x 900 x 750H

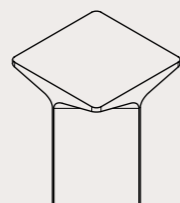

Pitcher Stool
375 x 375 x 450H

Earth Wirri c/o
Lucy Simpson



Earth Wirri takes its inspiration from bark coolamons, water carriers and other expertly crafted tools and utensils born of country over generations.

A simple, patterned vessel measuring around 600 millimetres in length, based on a bark coolamon and water carrier. A versatile piece – use it as display or on a tabletop – that celebrates the beauty and sophistication embedded within First Nations design.

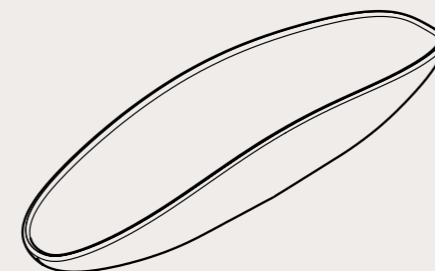

Earth Wirri
615 x 175 x 115H

Sol c/o
Hattie Molloy

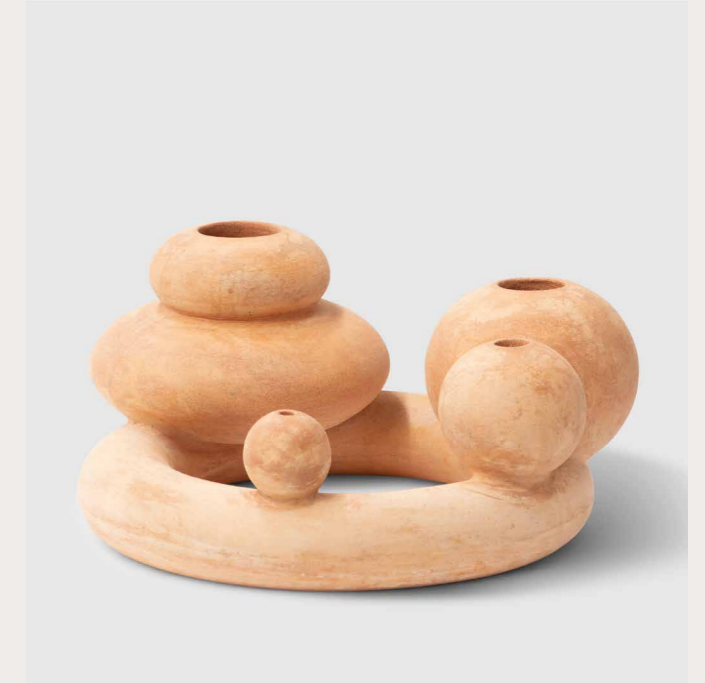

The intention behind Sol was to make people inquisitive and encourages them to look outside the realm of what's real or unreal.

A curvaceous terracotta form inspired by the at-times weird and wonderful shape of flowers. Designed for a practical purpose as a vase and incense holder, it can also sit on its own as a sculptural piece.

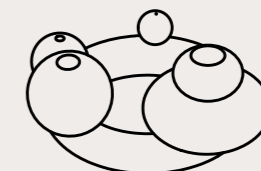

Sol
ø 380 x 215H

Echo c/o
Thomas Coward

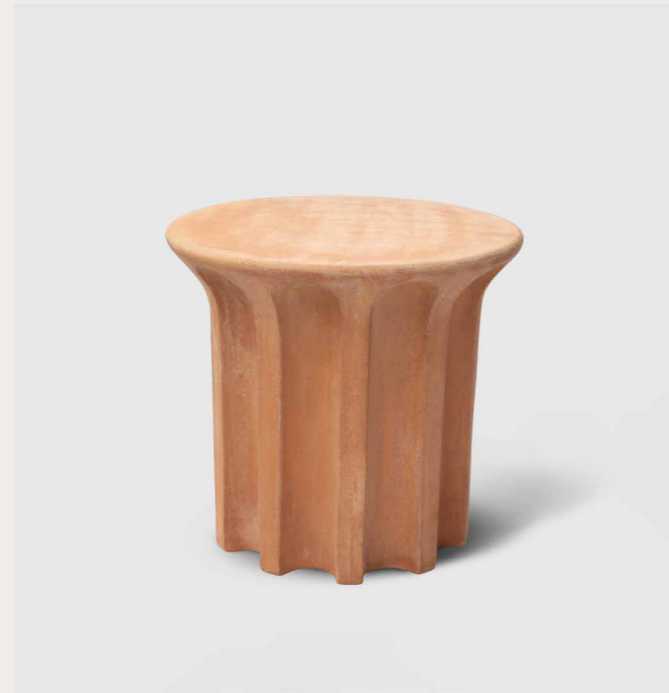

The form of Echo Low (above) and Echo High (right) are designed to defy time – referencing classical architecture and shapes that have been used for centuries.

Two robust terracotta tables featuring a revolving carousel of voids that call to mind the shapes used in architecture and design for centuries. A contemporary exploration of classical form that celebrates the history and legacy of this natural material.

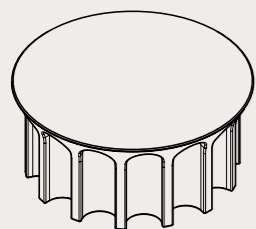

Echo Low
ø 900 x 400H

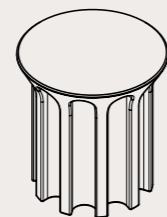

Echo High
ø 500 x 680H

Pinch c/o
Kate Stokes



The design of Pinch is quiet and unfussy – a celebration of pure geometry that can be seen equally as a wall sculpture and a functional guiding light.

A simple, elongated wall light, offered in two lengths – 400 millimetres and 900 millimetres. Its shield-like form is characterised by a central sharp line or 'pinch' that allows light to fall differently on each side of the terracotta, accentuating the natural beauty of the material.



Pinch 400
400 x 150 x 55D



Pinch 900
900 x 150 x 55D

Cove c/o
Thomas Coward



The Cove chair is designed to highlight the purity and strength of terracotta.

Two negative shapes are placed on top of each other, one creating lift, the other creating support. The Cove chair evokes the coastal formation that its name derives from; it exists by the absence of matter.

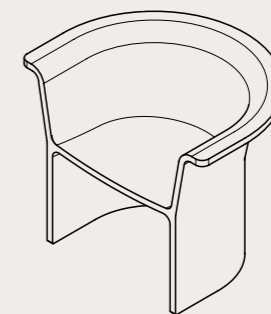

Cove
850 x 625 x 680H

Skáfos c/o
Chris Connell



'Skafos' – the Greek word for vessel. While the design of the pieces are contemporary, the entire process from sketch to completion was completed using traditional methods.

A free-flowing umbrella holder, inspired by the ribbed oil and water jars of Greece. The three-part, compartment-like form is tapered for stability and form-ribbed for strength. Included in the range is a smaller vase version, along with a fruit platter with a ribbed base, designed to allow fruit to breathe.

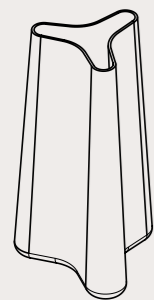

Skáfos Umbrella Stand
ø 365 x 635H

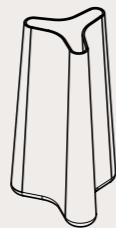

Skáfos Vase
ø 155 x 300H

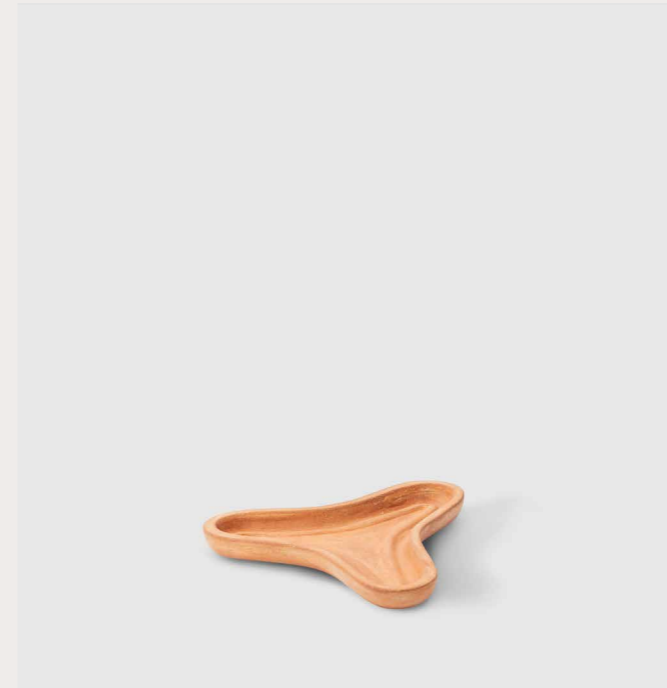

Skáfos Platter
ø 315 x 60H

Harvest c/o
Megan Morton

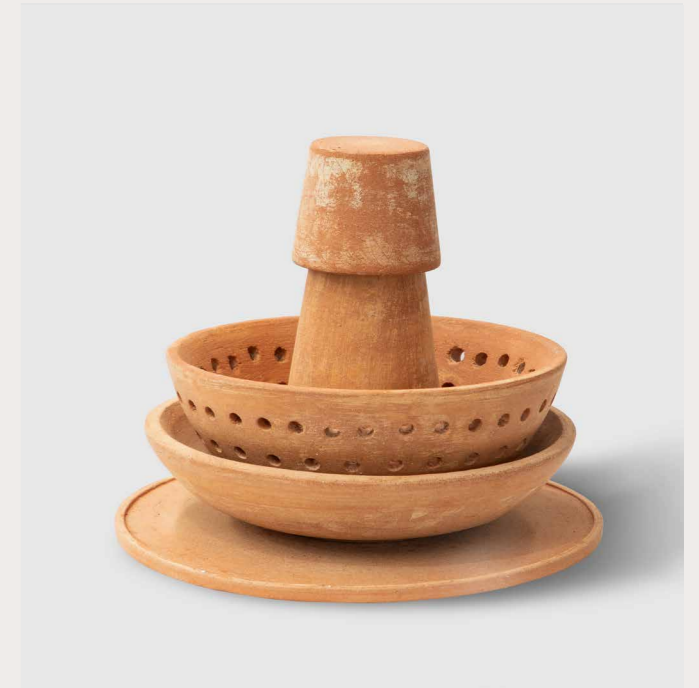

This suite will never fall – all the pieces of Harvest are extremely hard-working. When not in service, they fit together perfectly; when they are used, they are single-minded and independently beautiful.

A modular design consisting of five individual pieces that can be combined to create a tabletop sprout planter or used alone or in different combinations as a cake stand, serving plates, a dinner set or colander.

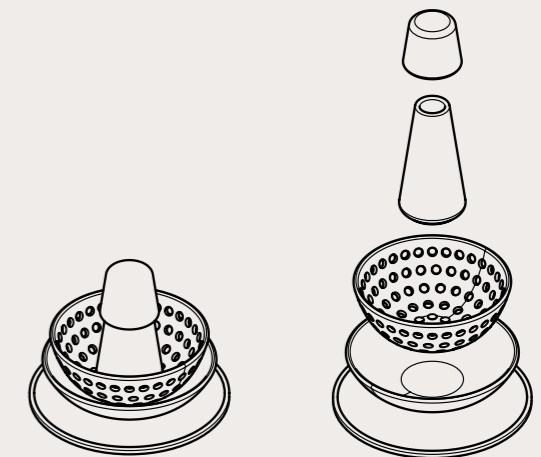

Harvest
350 x 275H

NEW VOLUMES™ c/o Artedomus

1300 046 604
newvolumes.com
@newvolumes

All dimensions are accurate at the time of print and subject to normal manufacturing variances and tolerances. New Volumes™ reserves the right to make changes without notification. Please check website for any updated dimensions.